

## CARACTÉRISTIQUES

- Montée sur deux roues fixes, facile à déplacer.
- Grilles facilement interchangeables.
- Aucun raccordement électrique nécessaire.
- Bac de fleurage magnétique.
- Encombrement réduit.
- Rangement pour 4 grilles.
- Fournie avec un bac de division et deux grilles.
- Découpe et mise en forme manuelle.

## FEATURES

- Mounted on two fixed wheels, easy to move.
- Cutting grids easily interchangeable.
- No electrical connection required.
- Magnetic flour box.
- Takes little space.
- Storage for 4 grids.
- Equipped with dividing bin and 2 cutting grids.
- Manual dough dividing and moulding.







## EIGENSCHAPPEN

- Gemonteerd op twee vaste wieltjes, gemakkelijk te verplaatsen.
- De roosters zijn gemakkelijk te verwisselen.
- Geen elektrische aansluiting nodig.
- Magnetisch bloembakje.
- Neemt weinig plaats in.
- Opbergruimte voor 4 roosters.
- Standaard met een verdeelbak en twee roosters.
- Manuele deegverdeling en -vorming.



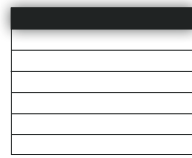
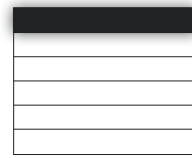







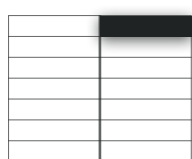
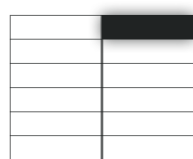

## GRILLES EN PLASTIQUE | PLASTIC GRIDS | PLASTIC ROOSTERS

### Simple division | Single division | Enkele verdeling

			
			
<b>MSG101001P</b>	<b>MSG080801P</b>	<b>MSG070107P</b>	<b>MSG060106P</b>
<b>10</b> (10 x 1)	<b>8</b> (8 x 1)	<b>7</b> (1 x 7)	<b>6</b> (1 x 6)
180 - 500 gr	225 - 625 gr	255 - 710 gr	300 - 830 gr
30 x 334 mm	41 x 334 mm	454 x 47 mm	454 x 54 mm

### Double division | Double division | Dubbele verdeling

					
					
<b>MSG201002P</b>	<b>MSG160802P</b>	<b>MSG140207P</b>	<b>MSG120206P</b>	<b>MSG100502P</b>	<b>MSG080402P</b>
<b>20</b> (10 x 2)	<b>16</b> (8 x 2)	<b>14</b> (2 x 7)	<b>12</b> (2 x 6)	<b>10</b> (5 x 2)	<b>8</b> (4 x 2)
90 - 250 gr	110 - 310 gr	125 - 355 gr	150 - 415 gr	180 - 500 gr	225 - 625 gr
30 x 160 mm	41 x 160 mm	224 x 45 mm	224 x 54 mm	155 x 80 mm	155 x 105 mm

**Grilles à couteaux profilés:**  
couteau en polyoxymethylene  
alimentaire profilé pour une soudure  
parfaite de la pâte lors de la division.

**Grids with angled blades:**  
food-proof polyoxymethylene angled  
blade for a perfect welding of the  
dough upon being divided.

**Roosters met profielmes:**  
voedingsgeschikt polyoxymethyleen  
profielmes voor een perfecte lassing  
van het deeg bij het verdelen.

## GRILLES INOX | STAINLESS-STEEL GRIDS | RVS ROOSTERS

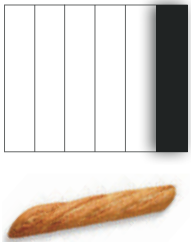

**MSG060601**

**6** (6 x 1)

300 - 1000 gr

73 x 334 mm

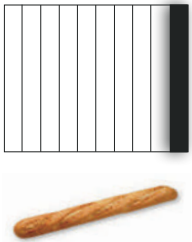

**MSG080801**

**8** (8 x 1)

225 - 750 gr

54 x 334mm

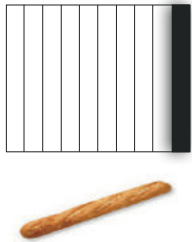

**MSG101001**

**10** (10 x 1)

180 - 600 gr

42 x 334 mm



**MSG100502**

**10** (5 x 2)

180 - 600 gr

88 x 160 mm

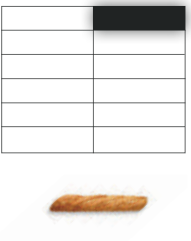

**MSG120206**

**12** (2 x 6)

150 - 500 gr

224 x 53 mm

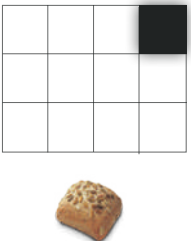

**MSG120403**

**12** (4 x 3)

150 - 500 gr

115 x 108 mm

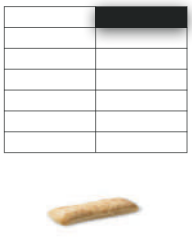

**MSG140207**

**14** (2 x 7)

125 - 425 gr

224 x 47 mm

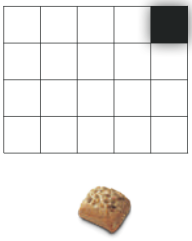

**MSG200504**

**20** (5 x 4)

90 - 295 gr

87 x 80 mm

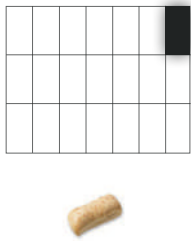

**MSG210703**

**21** (7 x 3)

85 - 285 gr

62 x 108 mm

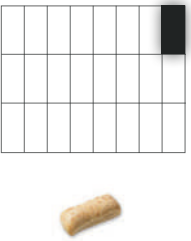

**MSG240803**

**24** (8 x 3)

75 - 250 gr

57 x 108 mm

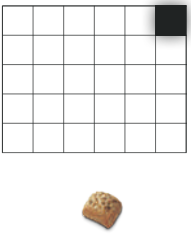

**MSG300605**

**30** (6 x 5)

60 - 200 gr

73 x 64 mm

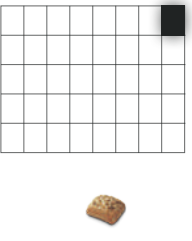

**MSG400805**

**40** (8 x 5)

45 - 125 gr

54 x 64 mm

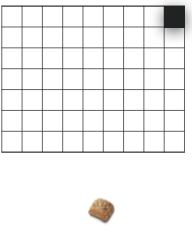

**MSG630907**

**63** (9 x 7)

25 - 63 gr

47 x 45 mm

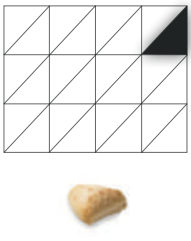

**MSG240403/2**

**24** (4 x 3) x 2

75 - 165 gr

115 x 108 x 150 mm

Poids et dimensions peuvent varier selon le type de pâte. ■ Weight and dimensions may vary depending on the type of dough. ■ Gewicht en afmetingen kunnen variëren, afhankelijk van het soort deeg.



Grilles facilement interchangeables.  
Cutting grids easily interchangeable.  
De roosters zijn gemakkelijk te verwisselen.

Bac de fleurage magnétique.  
Magnetic flour bin.  
Magnetisch meelbakje.

Support retractable pour le bac de division.  
Extractable support for the division bin.  
Uitschuifbare geleider voor de verdeelbak.

Plaque de tassage aussi disponible.  
Pressing plate also available.  
Drukplaat ook beschikbaar.

Rangement pour 4 grilles.  
Storage for 4 grids.  
Opbergrek voor 4 roosters.

Option: Echelle  
Option: Trolley  
Optie: Rek

Bacs   Bins   Bakken	14
Couvercles   Lids   Deksel	14
Capacité   Capacity   Capaciteit	9,8 L (5 - 6 kg)



VUE LATÉRALE | SIDE VIEW | ZIJAANZICHT

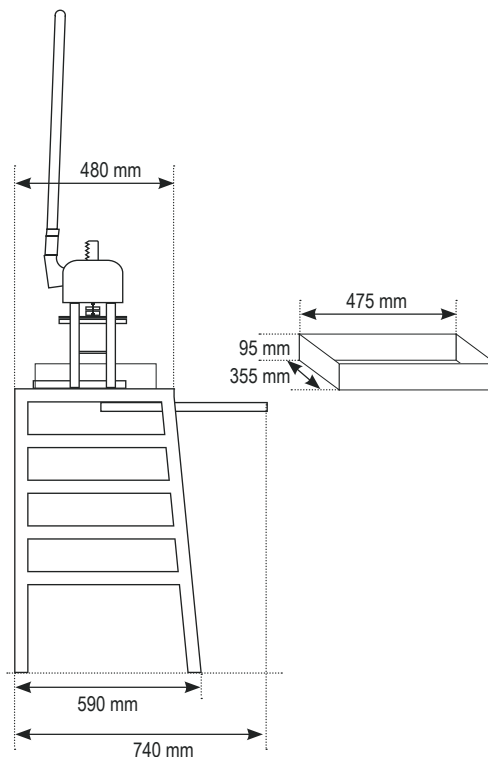

VUE DE FACE | FRONT VIEW | VOORAANZICHT

